

## FRANCÚZSKA NORMA



### Možnosti použitia



Typ 3 guľčkové vedenie  
Typ PA

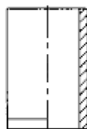

Priame puzdro  
pre guľčkové vedenie  
Typ GB

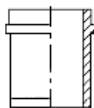

Krátke puzdro  
pre guľčkové vedenie  
Typ NB alebo HB

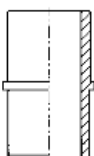

Štandardné puzdro  
pre guľčkové vedenie  
Type JB

### Priklady

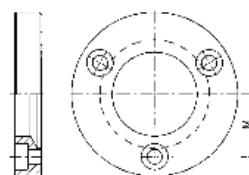
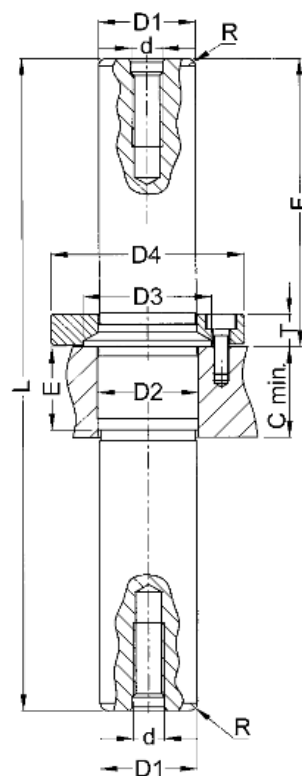
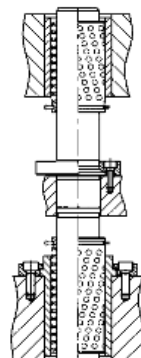
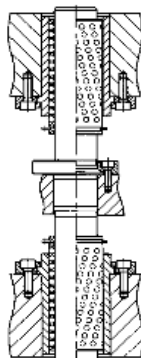
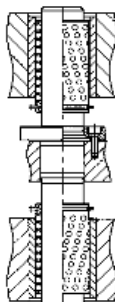

## FRANCÚZSKA NORMA

Objednávacie číslo: COM – EPO

Príklad objednania : COM - EPO - D1xL

Tvrdosť : 60 – 64 HRC

D1		20	25	32	40
L	F				
160	70	X			
180	80	X	X	X	
200	90	X	X	X	X
220	100		X	X	X
240	110			X	
250					X
D2		22	26	32,5	42
D3		27	33	40	49
D4		44	50	62	71
E		20	22	25	27
d		M8			
R		1,5	2,0		2,5
M		16	19	24	28
C mini.		22	24	27	29
T		9		10	11
Úpinky		P04 .020 .000	P04 .025 .000	P04 .032 .000	P04 .040 .000
Skrutky		A05 .004 .012 (M4x12)		A05 .005 .012 (M5x12)	A05 .006 .012 (M6x12)
Množstvo		3			